



ENGINEERED  
FOR THE NEXT GENERATION™



HD Foldable Drone with WIFI FPV  
**USER MANUAL**

NX-1800

v1



## **NX IS A PROUD DRONE SAFETY ADVOCATE**



### **Test your knowledge at [knowyourdrone.gov.au](https://www.knowyourdrone.gov.au)**

Be aware of local legislations and read the instructions carefully before using your drone. Keep yourself and others safe when flying your NX drone. Always fly your drone within visual line-of-sight and only fly one drone at a time. Do not allow your view of the drone to be impaired eg: in rain, wind, snow, fog or low light. When flying your drone, please keep in mind the safety and privacy of others.

Do not get your drone wet, dusty or sandy. Do not touch your drone while it is powered on and when the rotor blades are turning.

For replacement parts batteries, blades, and accessories please visit your nearest NX retailer or visit [www.nx-tech.com.au](https://www.nx-tech.com.au)

# CONTENTS

<b>1.0 WELCOME</b>	<b>3</b>
1.1 BEFORE YOU GET UP IN THE AIR	3
1.2 GENERAL SAFETY	3
<b>2.0 PRODUCT CONTENTS</b>	<b>4</b>
2.1 PRODUCT OVERVIEW	4
2.2 CONTROLLER OVERVIEW	5
<b>3.0 BATTERY SAFETY</b>	<b>6</b>
<b>4.0 SETTING UP YOUR NX-1800</b>	<b>8</b>
4.1 INSTALLING THE BATTERY	8
4.2 NX-1800 APP	8
4.3 REPLACING ROTOR BLADES	9
4.4 INSTALLING ROTOR GUARDS	10
4.5 REMOTE CONTROL	10
4.6 FLIGHT SAFETY	11
4.7 SYNCING YOUR NX-1800 DRONE	11
4.8 YOUR DRONE IS READY TO TAKE OFF	12
<b>5.0 FLYING YOUR NX-1800 DRONE</b>	<b>13</b>
5.1 BASIC FLIGHT	13
5.2 TRIM FUNCTION	13
5.3 SPEED MODE	14
<b>6.0 DOWNLOADING THE NX-1800 APP TO YOUR MOBILE PHONE</b>	<b>15</b>
6.1 WHERE TO DOWNLOAD	15
6.2 NX-1800 APP	15
6.3 CONNECTING TO THE NX-1800 WIFI	15
<b>7.0 CAMERA / VIDEO FEATURES</b>	<b>16</b>
7.1 VIEWING PHOTOS AND VIDEOS	16
7.2 CAMERA MODE	16
7.3 VIDEO MODE	16
<b>8.0 360° FLIP</b>	<b>16</b>
<b>9.0 HEADLESS MODE</b>	<b>17</b>
<b>10.0 ONE KEY REVERSE</b>	<b>17</b>
<b>11.0 EMERGENCY / STOP</b>	<b>18</b>
<b>12.0 DRONE MAINTENANCE</b>	<b>18</b>
<b>13.0 REPLACEMENT PARTS</b>	<b>18</b>
<b>14.0 WARRANTY TERMS &amp; CONDITIONS</b>	<b>19</b>
<b>15.0 NOTES</b>	<b>22</b>

## **1.0 WELCOME**

Thank You for purchasing a NX-1800 Drone, get ready to have the time of your life! We're sure your NX-1800 Drone will bring you a world of great experiences in the air. Please take the time to read the following safety warnings and operating instructions carefully.

## **1.1 BEFORE YOU GET UP IN THE AIR**

Before you familiarise yourself with the NX-1800 Drone, we ask that you read **page 6** before you start charging your drone's battery.

## **1.2 GENERAL SAFETY**

Please familiarise yourself with your local legislation regarding drone usage before you begin using your NX-1800 Drone. Included in the package contents of your NX-1800 Drone are the Australian CASA guidelines, please read carefully and understand this information as operating a drone outside of these guidelines may result in legal issues. NX takes no responsibility for operation of this product outside of what is legally permissible in your area.

- Do not fly your NX-1800 Drone any closer than 30 meters from people, animals or buildings. Check to make sure you are no closer than 5.5 kilometers from any airfields or airports. For more information on CASA's Australian legislation visit: <http://www.casa.gov.au/>
- You must not fly your drone higher than 120 meters (400 ft) above the ground.
- You must only fly during the day and keep your drone within visual line-of sight.
- For information outside Australia please visit the website of your local aviation authority.
- Do not attempt to modify the NX-1800 Drone or any of its components in any way, doing so will void your warranty and may affect the operation of the drone.
- Do not use the NX-1800 Drone in any conditions that could affect, damage or impair your view of the NX-1800 Drone including wet, dusty or sandy conditions. These elements will damage the components of your NX-1800 Drone.
- Please do not attempt to touch the NX-1800 Drone when the Remote Control is powered on, or if the rotor blades are turning.
- When flying your NX-1800 Drone, please keep in mind the privacy of others.

## 2.0 PRODUCT CONTENTS

1. NX-1800 Drone
2. Remote Control
3. Rotor Blades x 4
4. Rotor Guards x 4
5. USB AC Wall Charger
6. USB Charging Cable
7. Screw Driver
8. User Manual

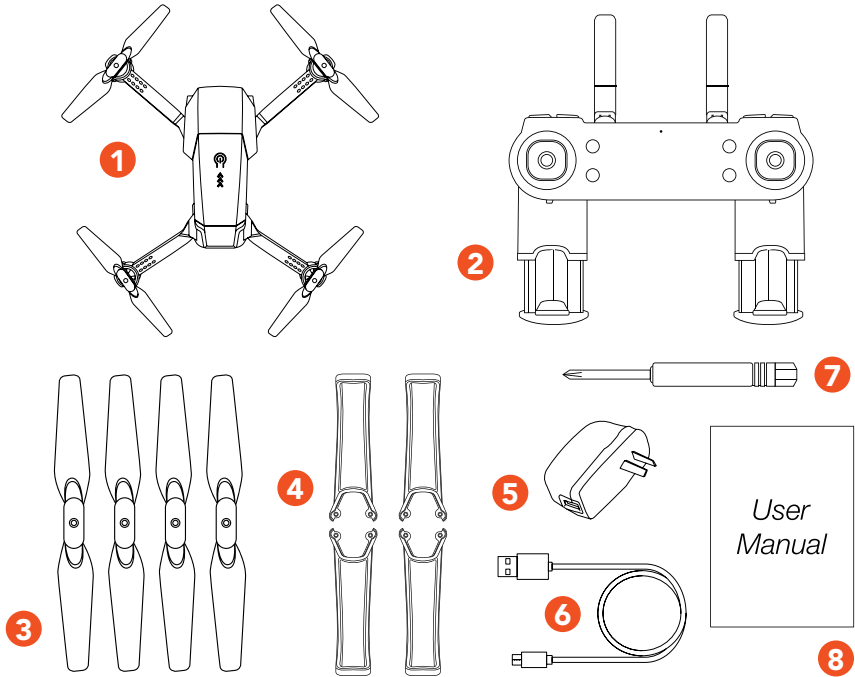

## 2.1 PRODUCT OVERVIEW

1. Camera
2. Rotor Blades
3. Motor
4. Power Button
5. Battery Release Button

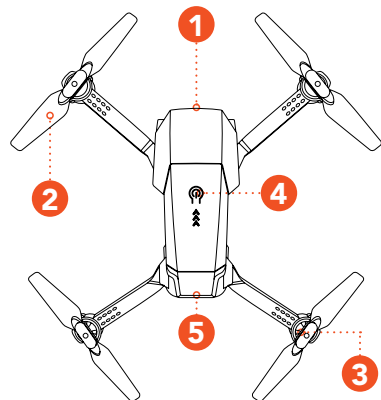

## 2.2 CONTROLLER OVERVIEW

1. Speed
2. Reverse
3. Left Control Stick (Pulse / Descend, Yaw Left / Right)
4. One Key Take Off / Landing
5. Emergency Stop
6. Right Control Stick (Forward / Backward, Left / Right)
7. Photo
8. Video
9. Headless Mode
10. 360° Flip
11. LED Power ON
12. ON / OFF

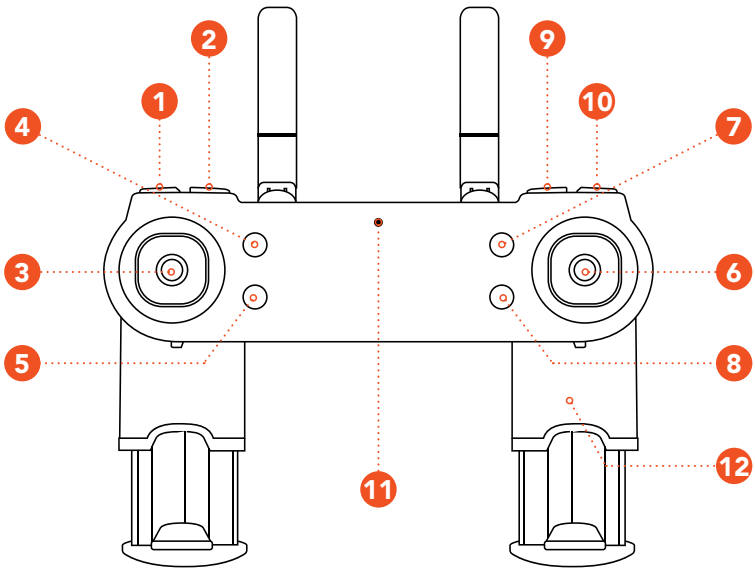

## IMPORTANT INFORMATION - PLEASE READ BEFORE USE

### 3.0 BATTERY SAFETY

When handled incorrectly, Lithium polymer batteries can be dangerous and can potentially harm and do damage to persons or property. NX does not accept any liability for damage to persons or property if the battery is not correctly charged, stored or protected.

- Always unwind all cables before charging.
- Do not over charge the battery. Once the charging process is completed, remove the battery from the charger as soon as possible.
- Only use the included or replacement NX-1800 chargers and batteries.
- You must charge the Lithium polymer battery in a safe area away from flammable materials.
- The battery is only to be charged under adult supervision, do not leave charging batteries unattended. You should always remain in constant observation to monitor the charging process and react immediately to any potential problems that may occur.
- Do not charge the battery in temperatures hotter than 40°C or colder than 0°C.
- Do not cover the batteries when charging. Do not leave batteries in direct sunlight.
- After each flight & or crash, please check batteries for any damage or swelling.
- If the battery is damaged, leaking, making noise, punctured or malformed in any way DO NOT attempt to use it. Please dispose of the battery immediately and safely in the correct manner.
- Do not bend, puncture, crush or scratch the drone's battery. Do not store batteries in your pockets, on your person or in extreme temperatures.
- After flying/discharging the battery you must allow it to cool to ambient/room temperature before recharging.
- If at any time during the charge or discharge process the battery begins to balloon or swell, discontinue charging or discharging immediately. Quickly and safely disconnect the battery, then place it in a safe, open area away from flammable materials to observe it for at least 15 minutes. Continuing to charge or discharge a battery that has begun to balloon or swell can result in a fire. A battery that has ballooned or swollen even a small amount must be removed from service completely.
- Never plug in a battery and leave it to charge unattended overnight.
- Non-compliance with the above warnings may result in the failure of the battery.



**PLEASE NOTE: YOUR NX DRONE COMES WITH A CERTIFIED NX USB AC CHARGING ADAPTER FOR 240V CHARGING OF YOUR DRONE BATTERY. USE OF A NON NX CERTIFIED USB AC CHARGING ADAPTER WILL VOID YOUR WARRANTY AND MAY DAMAGE BOTH YOUR BATTERY AND DRONE.**

Connect the drone battery to the charging cable. The light will glow red indicating charging is in process. The LED on the USB charging cable will turn off once charging is complete. To keep the battery life as long as possible, avoid removing the battery from the charging cable before charging is complete. If you have just finished flying your drone, please allow the battery to cool down for at least 30 minutes before recharging. When the battery has finished charging it is advised that the battery is removed from the charger as soon as possible. Overcharging will damage the battery and effect the flight time. The battery can take up to 50 minutes to fully charge. If the battery has been on charge for any longer than 2 hours and the indicator on the charging cable is not showing that the battery is charged, please remove the battery from the charger.

## 4.0 SETTING UP YOUR NX-1800

### 4.1 INSTALLING THE BATTERY

For detailed instructions on how to install the battery please follow the steps below.

1. Ensure that the battery is fully charged.
2. Insert the battery into the rear of the drone in the correct orientation (the tab on the battery should be facing down).
3. Slide the battery all the way in until it securely slots into place.

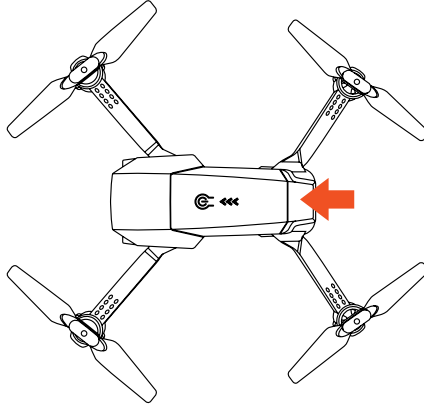

#### NOTE:

- Do not force the battery, if the battery does not fit into position, please check that you have installed the battery in the correct orientation.

### 4.2 NX-1800 APP

The NX-1800 drone has a built in WIFI connection which is used to wirelessly connect your smartphone to your NX-1800 drone allowing you to view the camera's live view, trigger recording, and control and fly your NX-1800 drone via FPV for up-to 50 metres.

#### NOTE:

- To record your video and save photos, you must connect your NX-1800 drone via WIFI to your smartphone, otherwise your footage will not be saved during flight.

1. To connect your smartphone to the NX-1800 drone please follow the instructions below.
2. Go to the Google Play store if you are using an Android smartphone, or The Apple Store if you are using an iPhone and search for the APP named "NX-1800". Once located download and install the APP.
3. To connect the APP, turn on the drone and go into the WIFI settings on your smartphone and select the connection named NX-1800\_XXXX. (Each 4 digit code is unique to each individual drone).

4. Once connected, open the NX-1800 App on your smartphone.

**NOTE:**

- When the drone has paired with the controller first, the APP will only operate to view real time video. The APP will not be able to control the drone's flying.

5. When the controller is turned off and your smartphone is used to connect with the drone, the APP can control the drone's flying.

### **4.3 REPLACING ROTOR BLADES**

If your rotor blades become damaged or the NX-1800 drone is no longer flying straight, the rotor blades may need to be replaced. To replace the NX-1800's rotor blades please follow the directions below.

There are two types of rotor blades included with the NX-1800, A blades (clockwise rotation) and B blades (counter clockwise rotation). The blades are marked on top showing either A or B. The arms of the drone are also marked A and B showing what blades each motor is compatible with.

It is important that the rotor blades are installed on the designated motors or else the drone may not fly and you could potentially burn out the drone's motors.

To remove and replace the rotor blades, please follow the instructions below.

1. Remove the rotor blades securing screw by unscrewing them counter clockwise with the screw driver (included).
2. Once the screw has been removed gently pull the rotor blade upward to remove the rotor blade from the motor stem.
3. Please ensure you identify and match the correct blade with the motor (A rotor blade to A motor, B rotor blade to B motor).
4. Place the new rotor blade over the motor stem and press it to ensure it is locked.
5. Replace and tighten the screw.

**NOTE**

- It is important that the correct rotor blades are installed on the correct motors. If they are installed incorrectly the drone will not fly and you could potentially burn out the drone's motors.
- When replacing multiple rotor blades please replace the blades one at a time to avoid any confusion in reattaching the rotor blades.

#### 4.4 INSTALLING ROTOR GUARDS

Installing the rotor guards is optional. Installing the rotor guards will protect your rotor blades and motors against bumps and light crashes.

1. To install the rotor guards please insert the rotor guard pegs into the designated holes near the motors on the NX-1800's arms and tighten the screw.
2. To remove the rotor guard, please unscrew the screws and then press the middle part of rotor guard first, then take the rotor guard out.

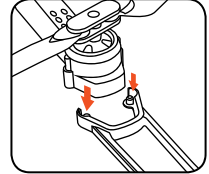
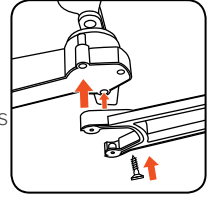

#### 4.5 REMOTE CONTROL

1. Extend the arms of the remote control.
2. Remove the battery cover on the rear of the remote control by sliding it downward.
3. Insert 2 x AAA batteries (AAA batteries not included) making sure that they are in the orientation specified.

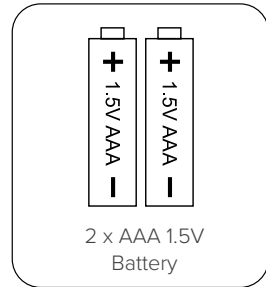
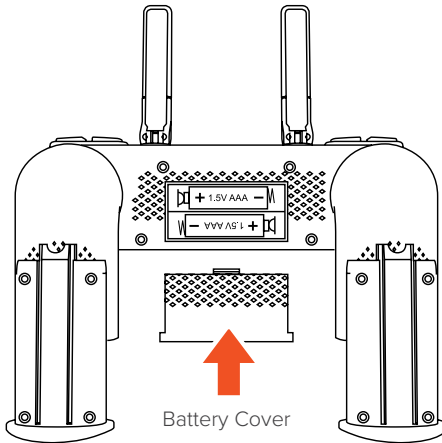

#### NOTE:

- The right arm of the controller is Power ON / OFF.
- By extending the arm lower, the controller will Power on make a beep sound and the Power Indicator will turn ON.
- Closing the right controller arm will turn off the controller.

## 4.6 FLIGHT SAFETY

Before flying your NX-1800 make sure that you are in a safe setting. CASA restrictions regarding flying drones require the drone to be no closer than 5.5kms from any airport or airfield while flying. Drones should also not be flown over populated areas or any closer than 30 metres from vehicles, people or animals.

It is also required that you check your surroundings before taking off making sure there are no obstacles or dangers in the area including overhead power lines and large bodies of water. If there are hazards present in your intended area of flight, please consider an alternative location.

## 4.7 SYNCING YOUR NX-1800 DRONE

1. Unfold the NX-1800 drone by extending the front legs first and then the back legs.
2. Press the ON/OFF button on the top of the drone to turn the drone on, the LED light of the drone will blink a blue colour (front) and a red colour (rear).
3. Extend the arms of the controller downwards, the controller will make a beeping sound and the LED indicator will Power On the controller.
4. Move the left control stick to the upside for 1 second and then move the left thumb stick to the downside for 1 second, the control will beep and the LED light of drone will stop blinking. The LED will change to solid blue in front and solid red in rear (**Fig 1**).
5. Please ensure that you have connected to your smartphone via WIFI before flying the NX-1800 drone. Please refer to **page 15**.
6. To Calibrate the drone, place the drone on a flat surface, and hold the left and right control sticks inward & downward (left stick 5 o'clock and right stick 7 o'clock positions) for 3 seconds. The indicator on the drone will change from constant light to quick flashing lights. When the LED light of the drone remains solid again, this means that the drone has been calibrated successfully (**Fig 2**).

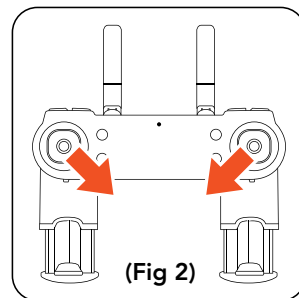
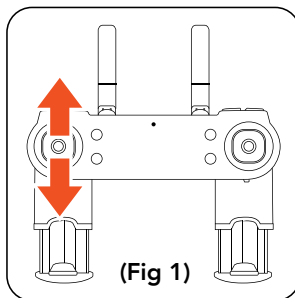

### NOTE:

- Please repeat step 6 before every flight.
- Please pair the controller frequency within 5m of the drone to avoid interference with other signals.

#### 4.8 YOUR DRONE IS READY TO TAKE OFF

Please ensure that the drone is kept on a flat surface and away from any obstructions.

There are 2 methods to begin flying your drone:

1. Press the One Key Take Off / Landing button **(Fig 3)**.
2. Press the left and right control sticks outward and downward (left stick 7 o'clock and right stick 5 o'clock positions) **(Fig 4)** for 3 seconds. The drone blades will start rotating and the drone is ready to fly by pushing the left control stick upwards **(Fig 5)**.

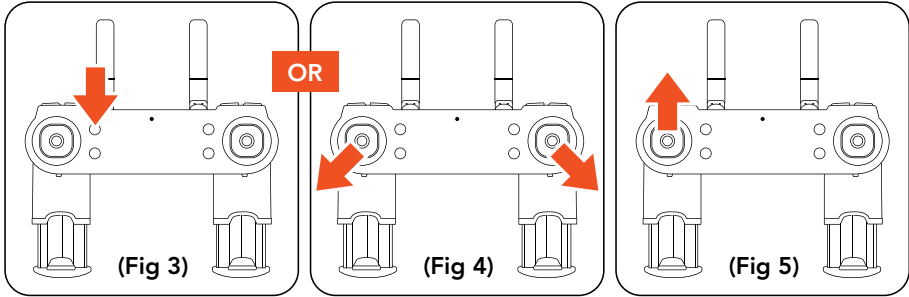

## 5.0 FLYING YOUR NX-1800 DRONE

### 5.1 BASIC FLIGHT

#### UP AND DOWN

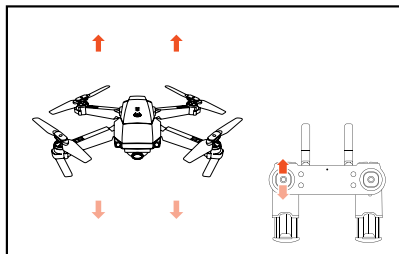

Push the left control stick up to gain altitude and down to descend

#### FORWARD AND BACKWARDS

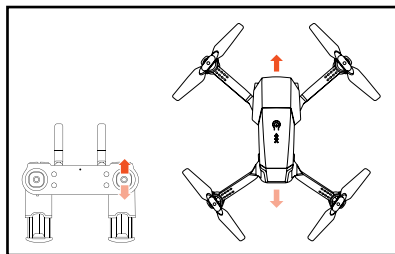

Push the right control stick up and down to fly forwards and backwards.

#### ROTATION

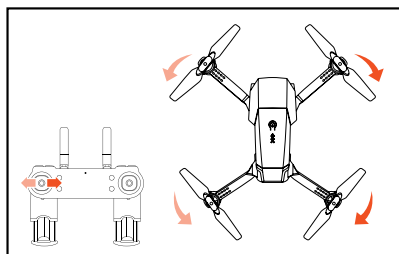

Push the left control stick left and right to pivot left/right.

#### LEFT/RIGHT FLIGHT

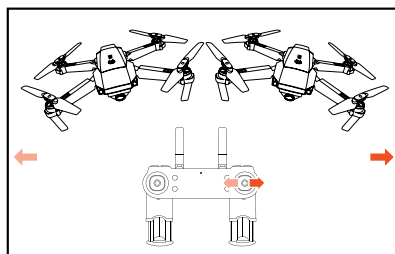

Push the right control stick left and right, to fly left/right.

### 5.2 TRIM FUNCTION

Trimming is used to balance out your drone if it is drifting when flying. To adjust the trimming please follow the steps below. You can only use this trim function when the drone is airborne.

1. Make sure that the Remote Control and NX-1800 are switched on and correctly paired.
2. With the right control stick centered, push down on it, once you hear the stick button click, release it. (This needs to be done each time you want to adjust trim in flight).
3. You can now adjust your trim using your left/right and up/down on your right controller stick. Please refer to the images 1-3 on Page 12.
4. To stop trimming, press down on the right control stick again.

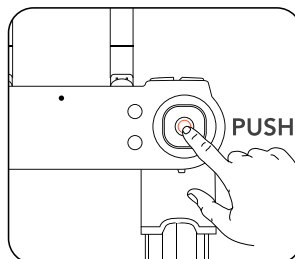

### TRIM FORWARD/BACKWARD

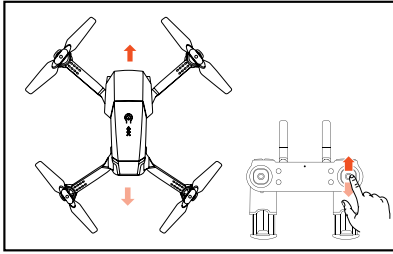

When the drone is hovering in place, and starts to drift forward, press the right control stick backwards until it's stable. If it drifts backwards, press the right control stick forward until it's stable.

### TRIM LEFT/RIGHT FLIGHT

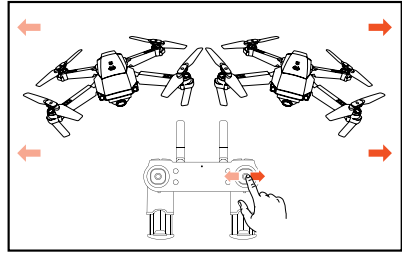

When the drone is hovering and starts to drift to the side, push the right stick to the left/right until the drone is stable.

### LEFT/RIGHT TRIM

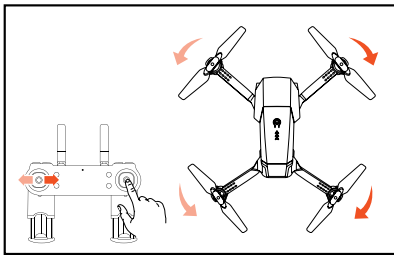

If the drone keeps rotating to left, press the left direction stick to the right until it's stable. If the drone keeps rotating to the right, press the left thumb stick to the left until it's stable.

## 5.3 SPEED MODE

The NX-1800 has 3 speed modes.

To cycle through the Speed Modes, use the speed button on the top left of the controller.

- Each mode will be identifiable by a series of beeps.
- Low Speed Mode (Default): One beep.
- Medium Speed Mode: Two beeps.
- High Speed Mode: Three beeps.

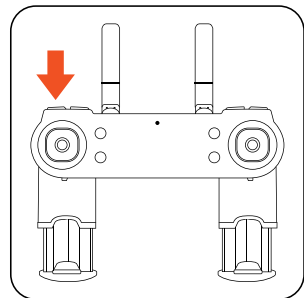

#### NOTE:

- For beginners it is suggested to operate the drone at Low Speed.



## 6.0 DOWNLOADING THE NX-1800 APP TO YOUR MOBILE PHONE

### 6.1 WHERE TO DOWNLOAD

#### For iPhones:

Go to the Apple App Store and search for the NX-1800 App.

#### For Android phones:

Go to the Google Play Store and search for the NX-1800 App.

### 6.2 NX-1800 APP



The NX-1800 drone has built in WiFi connection which is used to wirelessly connect your Smartphone to your NX-1800 drone allowing you to view the drone camera's live view, trigger recording, control and fly your NX-1800 drone.

To connect your Smartphone to the NX-1800 drone please follow the instructions below.

Go to the Google Play store if you are using an Android Smartphone, or the Apple Store if you are using an iPhone and search for the App named "NX-1800 or NX-1800", once located please download and install the App.

### 6.3 CONNECTING TO THE NX-1800 WIFI

1. Go to your smartphone's settings menu and enter the WiFi settings.
2. Turn on your NX-1800 drone.
3. If your smartphone WiFi is turned off, turn it on and search for NX-1800\_XXXXXXX in the available networks. Select NX-1800\_XXXXXXX, once the connection is successful a  icon will appear next to it.
4. Once connected, Open the NX-1800 App on your smart phone.

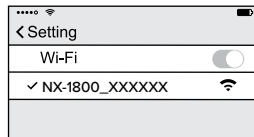

Minimum Smartphone Requirements (for use of the NX-1800 App). iPhone: iPhone 6 or later using iOS 8.0 and above. Samsung Galaxy: S5 and later using Mobile Android 5.0 and above. Minimum 3G network connection for GPS functionality. Apple, the Apple logo, and iPhone are trademarks of Apple Inc., registered in the U.S. and other countries. Google Play and the Google Play logo are trademarks of Google Inc. Industries.

## 7.0 CAMERA / VIDEO FEATURES

### 7.1 VIEWING PHOTOS AND VIDEOS

To view recorded footage and videos you will need to connect to the NX-1800 App.

### 7.2 CAMERA MODE

1. With the drone turned on and paired, press the Photo button.
2. The remote control will beep once and the LED lights of the drone will blink once to indicate that a photo was taken.

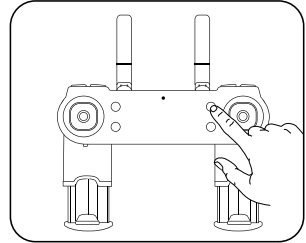

### 7.3 VIDEO MODE

1. With the drone turned on and paired, press the Video button.
2. The remote control will beep once and the LED lights on the drone will blink continuously to indicate that a video is being recorded.
3. Press the video button again to stop recording and the LED light on the top camera of the drone will stop blinking.

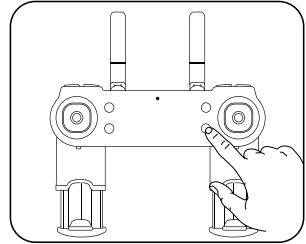

## 8.0 360° FLIP

Fly the drone to a height of more than 3 metres, then press the 360° flip button on the top right of your controller, afterwards immediately push the right controller stick in the direction you want to flip your drone.

### NOTE:

- 360° flips work better when the battery is fully charged.

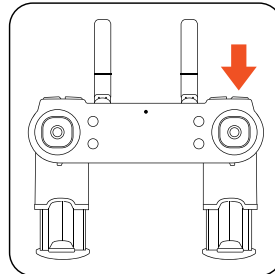
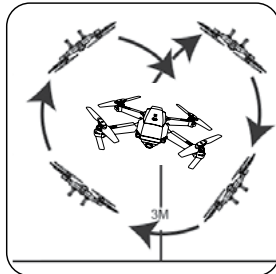

## 9.0 HEADLESS MODE

When headless mode is enabled, the drone will move in the direction that the remote controller stick is pressed, regardless of its orientation. This makes it easy to bring the drone home when it is far away from you.

To ensure headless mode works well, please use the correct take off position. The camera of the drone must point in the intended direction of flight; the back of the drone should be facing the pilot. See below instructions.

1. Press the headless mode button on the controller (shown in the diagram to the right). The remote control will beep once indicating that headless mode has been enabled. To stop headless mode, press the headless mode button again; the controller will beep again.

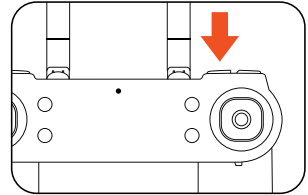

(Fig 6)

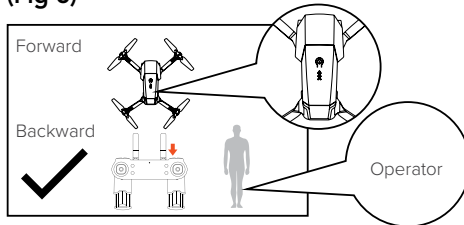

The correct take off position.

(Fig 7)

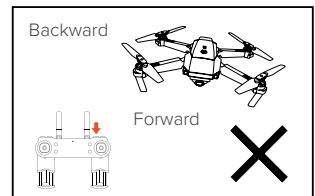

The incorrect take off position.

## 10.0 ONE KEY REVERSE

1. To ensure One key reverse works well, please ensure correct take off position as mentioned in section 9.0 (Fig 6 & 7).
2. While the drone is in flight, press the reverse button on the remote control, the controller will beep once and the drone will fly in reverse.
3. Press the reverse button again to cancel or push the right control stick in any direction to stop this function.

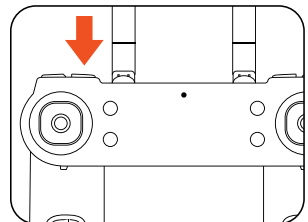

### NOTE:

It is highly recommended that you push the reverse button only when you are aware that it is safe to reverse.

## 11.0 EMERGENCY / STOP

1. While the drone is airborne and emergency is activated, the rotor blades will lock and the drone will fall to the ground.

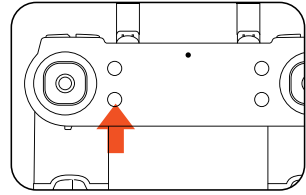

### NOTE:

- It is highly recommended that you do not push this button unless it is an emergency.

## 12.0 DRONE MAINTENANCE

Avoid exposing your NX-1800 drone and its accessories to dust, sand and moisture as these can damage the NX-1800 drone. If the NX-1800 drone is exposed to dust or sand, use a soft brush to remove any visible particles.

## 13.0 REPLACEMENT PARTS

We understand that it's not always easy learning how to fly a drone, and sometimes a close call can turn into a crash landing. For all spare part enquiries please contact our customer service team on +61 3 8331 4800 or visit our website [www.nx-tech.com.au](http://www.nx-tech.com.au).

## 14.0 WARRANTY TERMS & CONDITIONS

Our goods come with guarantees that cannot be excluded under the Australian Consumer Law. You are entitled to a replacement or refund for a major failure and for compensation for any other reasonably foreseeable loss or damage. You are also entitled to have the goods repaired or replaced if the goods fail to be of acceptable quality and the failure does not amount to a major failure.

This warranty is provided in addition to your rights under the Australian Consumer Law. Directed Electronics Australia Pty Ltd (Directed Electronics) warrants that this product is free from defects in material and workmanship for a period of 12 months from the date of purchase or for the period stated on the packaging. This warranty is only valid where you have used the product in accordance with any recommendations or instructions provided by Directed Electronics.

This warranty excludes defects resulting from alterations of the product, accident, misuse, abuse or neglect. In order to claim the warranty, you must return the product to the retailer from which it was purchased or if that retailer is part of a National network, a store within that chain, along with satisfactory proof of purchase. The retailer will then return the goods to Directed Electronics.

Directed Electronics will repair, replace or refurbish the product at its discretion. The retailer will contact you when the product is ready for collection. All costs involved in claiming this warranty, including the cost of the retailer sending the product to Directed Electronics, will be borne by you.

**NX Address:** 115 Link Rd, Melbourne Airport VIC 3045

**Ph:** +61 (03) 8331 4800

**Email:** [service@nx-techcom.au](mailto:service@nx-techcom.au)

### INDEMNITY

You agree to defend, indemnify and hold harmless NX and its subsidiaries and affiliates from and against any and all claims, proceedings, injuries, liabilities, losses, costs and expenses (including reasonable legal fees), including but not limited to, claims alleging negligence, invasion of privacy, copyright infringement and/or trademark infringement against NX and its subsidiaries and affiliates or the NX services, relating to or arising out of your breach of any provision of these terms, your misuse of the NX or NX services, or your unauthorized modification or alteration of products or software.

## **WARRANTY AND WARRANTY DISCLAIMER**

NX has a limited warranty on whereby NX warrants to you and only to you that the NX drones and accessories will be free from defects in materials and workmanship for one (1) year from the date of your purchase of the on NX drones and accessories, computer software, or other hardware (unless a longer warranty period is required by law). The specifics of this NX limited warranty are at <https://www.nx-tech.com.au/warranty>

To the extent possible under governing law, other than the above product warranty for the NX drones and accessories, computer software, or other hardware you understand and agree that the NX services are provided on an "as is" and "as available" basis. NX makes no warranty that the NX services will meet your requirements or that use of the NX services will be uninterrupted, timely, secure or error-free nor does NX make any warranty as to the accuracy or reliability of any information obtained through the NX services (including third party content), that any defects in the NX services will be corrected or that the NX products or NX services will be compatible with any other specific hardware or service. Further, NX does not warrant that the NX services or the NX servers that provide you with data and content are free of viruses or other harmful components. NX also assumes no responsibility for and shall not be liable for any damages caused by viruses that may infect your NX drones and accessories, computer software, or other hardware.

NX's equipment and services do not cause and cannot eliminate occurrences of certain events, including, but not limited to, fires, floods, burglaries, robberies and medical problems. NX makes no guarantee or warranty, including any implied warranty of merchantability or fitness for a particular purpose, that the NX equipment and services provided will detect or avert such incidents or their consequences. NX does not undertake any risk that you or your vehicle or property, or the person or property of others, may be subject to injury or loss if such an event occurs. The allocation of such risk remains with you, not NX.

Other than the above product warranty for the NX drones and accessories, computer software, or other hardware, NX and its suppliers disclaim all warranties of any kind, whether express, implied, or statutory, regarding the NX equipment and any associated app/service. Including any implied warranty of title, merchantability, fitness for a particular purpose, or non infringement of third party rights. Because some jurisdictions do not permit the exclusion of implied warranties, the last sentence of this section may not apply to you. NX hereby further expressly disclaims all liability for any claims for service failures that are due to normal product wear, product misuse, abuse, product modification, improper product selection or your non-compliance with any and all applicable federal, state or local laws. This warranty and warranty disclaimer give you specific legal rights, and you may have other rights that vary by state, province, or country. Other than as permitted by law, NX does not exclude, limit or suspend other rights you have, including those that may arise from the nonconformity of a sales contract. For a full understanding of your rights you should consult the laws of your state, province, or country.

For our Australian Customers: please note that this warranty is in addition to any statutory rights in Australia in relation to your goods which, pursuant to the Australian consumer law, cannot be excluded.

### **LIMITATIONS OF NX LIABILITY**

Under no circumstances will NX be liable in any way for any content, including, but not limited to, the loss of content, any errors or omissions in any content, or any loss or damage of any kind incurred in connection with use of or exposure to any content posted, emailed, accessed, transmitted, or otherwise made available via the NX app.

NX liability for damages, especially for breach of duty or obligation, delay in performance, non-performance, or malperformance shall be precluded, except when these are due to negligent breaches of any significant contractual duty or obligation on the part of NX. Any liability for negligence is limited to direct losses usually and typically foreseeable in such case. Should the claim for damages be based on willful or grossly negligent breach of contractual duty or obligation on the part of NX, the preclusion and limitation of liability mentioned in the preceding sentences will not apply. The preceding preclusion and limitation of liability will also not apply to claims for damages arising out of loss of life, bodily injury or health impacts for which NX may be liable, or for non-contractual liability.

Some states and countries do not allow the exclusion or limitation of incidental or consequential damages, so the above limitation or exclusion may not apply to you. Additionally, this provision is not intended to limit NX's liability in the event of NX's willful or intentional misconduct.











ENGINEERED FOR THE NEXT GENERATION™

